

Article number: 03446100

Description: Fluro Heavy Duty Spherical Plain Bearing GE 100 GW-2RS
Hole Ø100

Note: 100

Measures

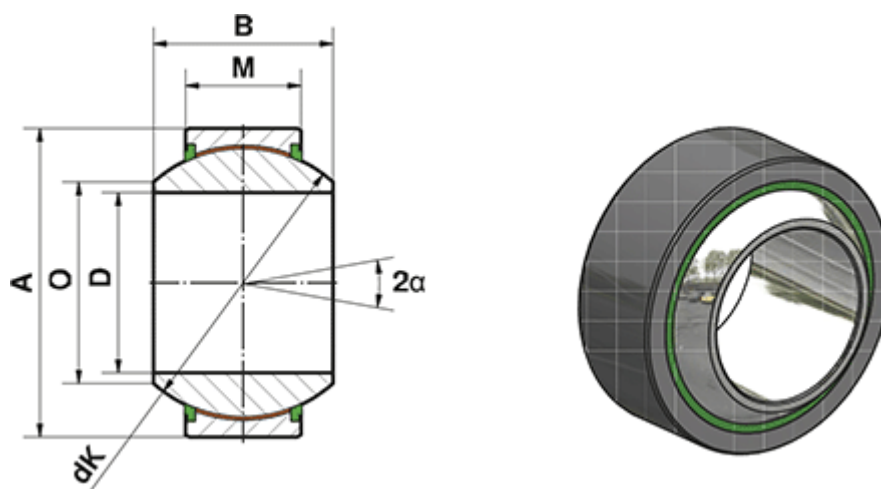

| | | |
|-------------|-------|----------------------------|
| | = - | Dynamic load C (kN) = 1845 |
| | = - | M = 55 |
| | = - | O = 111.2 |
| A | = 160 | Static load C0 (kN) = 3075 |
| a (degrees) | = 14 | Weight (g) = 6000 |
| B | = 85 | |
| D | = 100 | |
| dK | = 140 | |